REVO



Zachary Szczesniak, Team Captain
Milos Zefran, Sponsor

zszcze2@uic.edu
mzefran@uic.edu

Michael Dritlein, Lead Software Design
Lisa Soderlind, Lead Mechanical Design
Savim Acharya
Mohammed Arshad
Michael Banasik
Jessica Konecki

mdritl2@uic.edu
soderli2@uic.edu
sachar5@uic.edu
marsha6@uic.edu
mbanas6@uic.edu
jkoneck2@uic.edu

Contents

1	Team organization and Design process	2
1.1	Introduction	2
1.2	Organization	2
1.3	Design assumptions and design process	2
2	Vehicle Design Innovations	2
2.1	Modular Hardware Design	2
2.2	System Monitoring	3
3	Mechanical Design	4
3.1	Overview	4
3.2	Mechanical Drive Module	4
3.3	Sensor and Electrical Housing Module	5
3.4	Payload Housing	6
4	Electronics and Power Design	6
4.1	Overview	6
4.2	Power Distribution System	7
4.3	Blinker Circuit	7
4.4	E-Stop System	7
4.5	System Monitor	8
4.6	Motor Controller	8
5	Software Design	8
5.1	Overview	8
5.2	Obstacle Detection and Avoidance	9
5.3	Software strategy and path planning	9
5.4	Map generation	9
5.5	Goal selection and path generation	9
6	Failure Modes, Failure Points, and Resolutions	11
6.1	Failure Modes	11
6.2	Points of failure	12
6.3	All failure prevention strategy	12
6.4	Testing	12
6.5	Vehicle safety design concepts	12
7	Simulations employed	12
7.1	Simulations in virtual environment	12
7.2	Theoretical concepts in simulation	13
8	Performance Testing to Data	13
8.1	Component testing, system and subsystem testing, etc.	13
9	Initial Performance Assessments	14
10	Conclusions	15
11	Appendix	16

1 Team organization and Design process

1.1 Introduction

REVO (ROS Enabled Vehicle Operation) was initially constructed in 2016 with the intention of simplifying the previously used mechanical system. This year, emphasis was put refining the software models as well as streamlining other concepts or ideas that either did not work, or never came to fruition in the previous year. The design process began and ended in the fall and winter of 2017, respectively. Manufacturing began winter 2017 and continued throughout May 2018.

EDT's executive board consists of a President, Vice President, Treasurer and Secretary. After the hierarchy of officials, captains and any other non-executive positions are decided. EDT has been an official organization at UIC for 14 years, and IGVC is one of few competitions this organization competes in annually.

1.2 Organization

Three teams are split by REVO's mechanical, electrical, and software needs. The mechanical team was in charge of designing the drive train, organizing the electrical housings, and building various mechanical components for the robot. The electrical team was in charge of designing the circuit boards, distributing the power to the various on-board computers, and wiring the robot efficiently. The software team dealt with the identification of obstacles and lanes; this information was then used in a costmap to calculate a path from its current position to the GPS way point.

1.3 Design assumptions and design process

A set of design criteria was determined through a lengthy process of assessing the performance of the previous years' design, examining similar versions, and deciding which features were the most useful in terms of functionality and feasibility, given the limitations of time and means of production.

Within the limitations, several primary areas of REVO were redesigned. The primary mechanical system including the drive train was deemed sufficient for reuse. The payload module was redesigned from scratch, while the electrical and sensor housing module was reworked for wire management, sealing, and rigidity. The majority of REVO's software was kept from the previous year. A neural network and semantic segmentation model were developed for optimizing line detection.

2 Vehicle Design Innovations

2.1 Modular Hardware Design

REVO integrates concepts from various ground vehicles. The primary design goal was to design a platform that would be easy for operators to handle and make changes to in the field. It features a sliding drawer that provides access to the primary electrical hardware. It

also houses the connections to each sensor and embedded platform. In addition to this, both the mechanical and electrical hardware are divided into sub-systems that are easily attached and detached to allow for different areas to be tested while others might be redesigned or reconstructed.

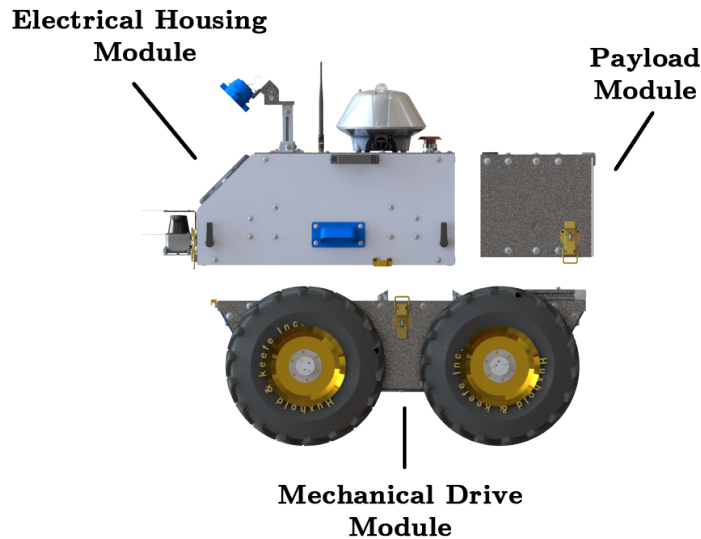

Figure 1: Hardware Modules

2.2 System Monitoring

REVO features a system monitor that can record data for temperature and humidity as well as data from the motor controller or the embedded computer. This system is comprised of a touch screen LCD tablet which runs the latest version of Ubuntu. The tablet then runs a C program that displays a Graphical User Interface on the screen. The GUI is designed to allow for convenient observation of multiple sub-systems. This accelerates the process of problem identification and analysis. The tablet receives data from the system monitor, through UART, to be parsed and used by the GUI. All quantitative values are continuously displayed in a tabbed window. There are tabs for the E-stop status, sensor values, and NUC data. Values can be selected to be displayed in a continuously updated graph. This allows for quick comparison of present values to past values in order to identify potential trend lines and undesired fluctuations, reducing errors in REVO's overall operation.

3 Mechanical Design

3.1 Overview

REVO is based on previous EDT robots with an aim to make it smaller and simpler. The design goal of REVO's chassis was to make the platform more manageable for operators to handle in the field. This was accomplished by reducing its size as well as minimizing points of failure. The large gear boxes from the previous design were dropped in favor of pre-purchased DC motors which include planetary gear boxes. This lessened the distance between the wheels. Two of these motors were used, one at each end of the robot, and they were coupled to the wheels on each side using belts. One problem that was encountered was the length of the motors with the attached gear boxes. This was a critical constraint to keep the size of the design to a minimum. This was overcome by multiple design revisions, sourcing the correct components, and collaborative research and design.

REVO is comprised of two sub-assemblies. The lower assembly contains all the necessary components to achieve mechanical motion. The upper assembly contains the essential electrical systems, as well as a modular area for extra features, such as the containment of a payload. The modular design coupled with the idea of an upper and lower assembly worked well during design and field testing. Therefore, these ideas were implemented early on within the design process.

From its inception, REVO was designed with weather-resistance in mind. Several measures were taken to ensure that each panel was sealed to prevent the intrusion of moisture and other foreign particles. This was done first through design using tight tolerances, then through the application of foam strips, rubber gaskets and caulk where necessary.

3.2 Mechanical Drive Module

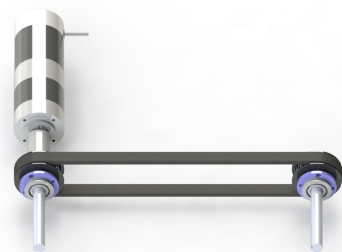

Figure 2: Drivetrain

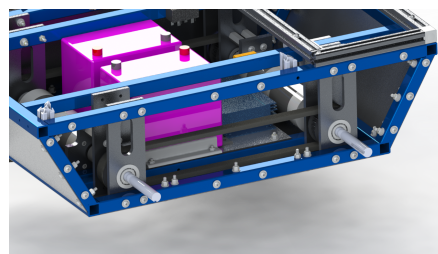

Figure 3: Side View

Since there were simplifications that needed to be implemented, a new drive train was created. As mentioned earlier, and shown in the figure above, there are two motors that drive each side of REVO. Due to how the drive train worked, the shape of the frame had to be considered. The new shape was constrained by the minimum length of the robot being three feet, the minimum width being two feet. This size was decided upon through examination of other robots designed by EDT which are much easier to transport and operate.

The reasoning for a non-rectangular frame is the aspect ratio: the ratio of length to width. Ideally, the aspect ratio should be as small as possible because of the skid-steering decision and the stresses that occur when ratio is increased. This constraint of the aspect ratio was overcome by choosing an isosceles trapezoidal frame. This allowed the wheels to be closer together, effectively decreasing the aspect ratio, and also staying within the length constraint. The frame is constructed out of welded 1040 carbon steel. Steel was chosen due to its high strength, low cost, and desirable fatigue limit. The frame was then powder-coated to prevent oxidation and improve aesthetics.

Through the examination of the required design criteria, as well as the success of previous EDT designs, a traditional spring and damper suspension system was deemed unnecessary. Instead, REVO uses a simple rigid drive system that transfers power from the motors gearbox directly to two drive shafts using coupled timing pulleys. The need for a suspension seemed arbitrary since the terrain is not particularly challenging. We have improved ground clearance, which was another constraint that we overcame through trial and error. The ground clearance of EDT's previous IGVC robot was just under 2 inches, compared to this year with REVO's clearance of 5 inches. The limiting factor to the ground clearance is the organization of the drive train. Since the motors are directly coupled to the wheels, the distance the motors are from the bottom of the chassis needed to be minimized and the wheel diameter needed to be maximized. However, there is always room for improvement and further design restraints needed because the motors speed and torque are dependent on the wheel size if the desired speed and acceleration are to be kept.

3.3 Sensor and Electrical Housing Module

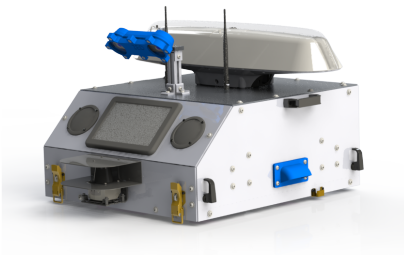

Figure 4: Electrical Housing Module

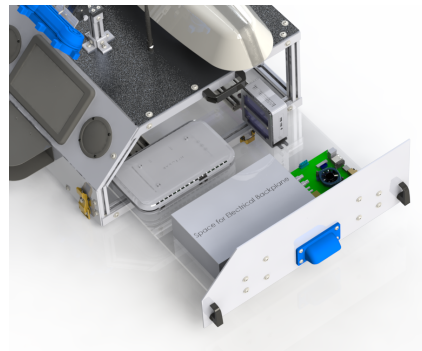

Figure 5: Module with drawer open

The upper assembly was a completely new design to EDT. Although the use of drawers wasn't a novel idea, housing all the computers and electrical hardware in the same space was a new concept. In previous years, the electrical hardware and computers were separated into categories and each category had its respective spot. This year, EDT decided to use a single pull-out drawer. The main advantage was to increase the space for hardware and increase the ease of installation. The frame of the upper assembly was made of an 80/20 aluminum T-slot extrusion. Although the T-slot's peripheral components made it more expensive, the reconfigurability offered by the T-slot was determined to be worth the extra cost.

3.4 Payload Housing

One major improvement to REVO’s design is the addition of a more robust payload housing. Made with aluminum, with inside dimensions of 10” x 10” x 21”, the payload was designed to comfortably fit multiple small items, or one large item, while also being more aesthetically pleasing as the payload box now fits the profile of REVO. The payload is outfitted with a rear-facing hatch door that opens upward up to 90 degrees, providing easy access to the payload. A mechanism is attached to the payload housing that allows for the payload door to be held up easily, and close slowly such that the door does not slam into the housing, causing damage. The door is also outfitted with a handle to allow for easy opening and closing of the door. In addition, an aluminum U-channel is inserted at the rear of the payload box, allowing a series of cables to be run through from the bottom sub-assembly to the top sub-assembly through a series of holes. Although it sacrifices some depth, the U-channel still allows ample room for carrying various items. The hole at the top of the payload is sealed with a grommet for weatherproofing. Custom 3D printed brackets were manufactured to limit horizontal sliding within the payload while REVO is turning.

4 Electronics and Power Design

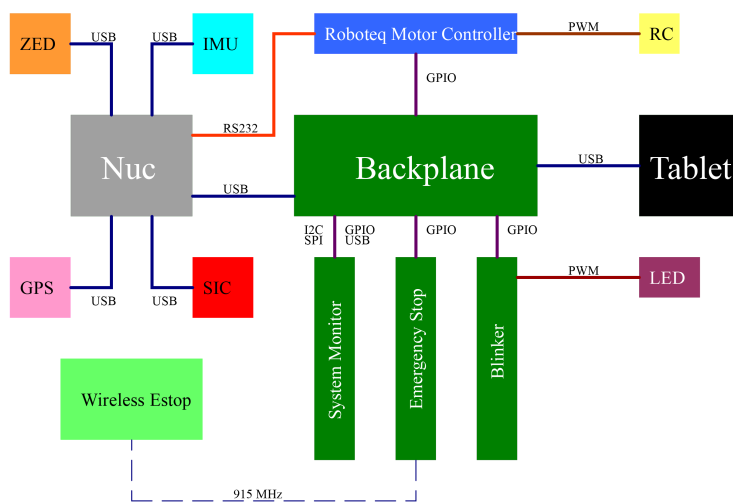

Figure 6: Electrical System Schematic

4.1 Overview

REVOs main electrical system is comprised of a redesigned backplane, built in NUC computer, Roboteq HDC2450 two channel motor controller, as well as an array of sensors including a high resolution ZED camera and a Sick-TiM551 laser range finder. The backplane acts as the hub for REVO. It is constructed from a professionally printed circuit board which has

three removable cartridges allowing for easy modifications to those systems. The main task of the backplane is to power the multiple components of the electrical design using a 12V and 5V regulator. Connected to the 12V regulator are the Intel NUC, the ZED Camera, the SICK-Tim laser scanner, and LCD system monitor. Connected to the 5V regulator are the emergency stop and high visibility warning light to indicate the mode of the robot. The size of the backplane was reduced by integrating a edge card design.

4.2 Power Distribution System

REVO is equipped with two 12V 35Ah batteries wired in series providing 24V to the Roboteq and the backplane. REVO received a redesigned breakout board that acts like a terminal block splitting the batteries leads to go to the respective systems. The breakout board allows for more efficient wiring and power distribution.

4.3 Blinker Circuit

One of the removable cartridges from the backplane is the Blinker card. This card operates ultra bright LEDs controlled using a custom designed library. The LEDs are used, coded per the rules, to show the current mode of the robot.

4.4 E-Stop System

REVO is equipped with an emergency stop that consists of a handheld unit and a removable PCB cartridge located on the backplane of the robot. The handheld unit and PCB cartridge communicate with each other wirelessly using an EVM-915-DTS transceiver produced by Linx Technologies, due to its simple yet effective interface and excellent range. These transceivers use UART serial communication to send data to each other, notifying the robot what mode it should set itself to (Safe Mode, Radio Control (RC) Mode, Autonomous Mode, or Emergency Mode). The data that the transceivers on the handheld unit and PCB cartridge send and receive are processed by an Atmega8-PU microcontroller, which determines which mode has been selected based on the data it receives from the transceiver as well as from the button inputs from the handheld and robot itself. The wireless emergency stop includes the following safety features: boot into Safe Mode, mode priority, and Atmega8s watchdog. Booting into Safe Mode prevents loss of power from the handheld, since REVO will lose power when it is placed into Safe Mode. Mode priority was implemented so that, in the event of the accidental selection of more than one input at the same time, the emergency stop system will select the mode that is considered the safest of all the inputs pressed. Each mode is ranked in the following order, with 1. being the safest: 1. Emergency Mode, 2. Safe Mode, 3. RC Mode, 4. Autonomous Mode. The Atmega8-PU's watchdog function is used to automatically restart the microcontroller in the event of a microcontroller malfunction or unforeseen bug in the code, since a manual restart will not be feasible in the competition.

4.5 System Monitor

The system monitor cartridge of the backplane, an ATmega8 microcontroller, serves as a collector of data to be sent to the tablet. Multiple systems are continuously monitored to allow for easier and quicker debugging as well as insight into the present status of the robot. Sensors are utilized to check physical conditions. The sensors used are: an optocoupler, a J type thermocouple, and a humidity sensor to measure battery voltage, temperature, and humidity, respectively. This data is received through the ATmega8s ADC and converted for proper transmission. Data that can be used to debug and observe the NUC and E-stop systems is also sent to the system monitor. The NUC sends CPU consumption, RAM consumption, number of running nodes, crash reports, and GPS coordinates to the system monitor through UART. The E-Stop system is connected to the system monitor, through GPIO, in order to report the E-Stop status. All data received by the system monitor is then continuously transmitted to the tablet through UART. This data is then utilized in the Graphical User Interface (GUI) program.

4.6 Motor Controller

REVO uses a Roboteq HD2450 two channel motor controller. This controller has an internal memory that is able to hold instructional scripts that dictate the operation of the controller. EDT wrote a custom script that allowed for mode selection over the controllers GPIO pins. The script also assigned the proper channels of communication to each mode. For example, when the mode selection pins indicated RC mode, the controller only executed data from the RC data lines. This feature prevents unwanted data from interfering with the intended operation of REVO, making the robot safer.

5 Software Design

5.1 Overview

The previous experience with Robotic Operating System (ROS) from previous years prompted continued development of the software system using this set of libraries. ROS is a dedicated, open-source platform for robots that provides a standard communication channel between software nodes and motor controllers. The software nodes can monitor the robots environment, make plans based on present and past information, and act accordingly by sending commands to the motor controllers. The use of ROS allows quick and efficient design of modular nodes which are each made to handle specific tasks and can be modified, replaced, or removed without affecting the function of other nodes. Many nodes and libraries have also been written and shared by ROS' large online community, which is advantageous because of it's accessible, active, and collaborative community. The simulation and testing tools for ROS, including the ability to "bag" data and replay it, are RVIZ, and Gazebo. Each of these have proven to be invaluable due to being user-friendly, and having the capability to test the system as a whole, or individual components, without the use of the physical robot. This allows for testing to be performed online, while other members could use the physical robot or while the robot is not in a state of functionality.

5.2 Obstacle Detection and Avoidance

To detect obstacles, REVO uses a laser rangefinder (LRF) which is a SICK TiM551. Its driver is a ROS node that requires a few parameters from the rangefinder such as the minimum and maximum viewing angle. Once launched, the node connects to the LRF and begins publishing “laser_scan” messages. The navigation stack listens to these laser_scan messages and places the obstacles found at relative positions onto its costmap and then takes appropriate measures to avoid collisions.

5.3 Software strategy and path planning

ROS nodes are contained in packages. Packages can be groups of nodes sharing similar functionality such as mapping, navigation, or individual nodes responsible for unique tasks. Data is collected and modified by the sensory nodes, and is then sent to the navigation stack. Along with this, the navigation stack also uses REVO’s location, orientation, and velocity. Once the current state is determined, it is compared to a defined goal to determine the steps needed to attain the desired state. The navigation stack then communicates with the motor controller and indicates a speed and direction of movement. The navigation stack continues to monitor the data sent by the motor controllers to measure and update progress, while also adjusting the robot’s velocity to reach the goal.

5.4 Map generation

In the previous year, ROS’ SLAM gmapping library had been used, which builds a map using laser scan and odometry data as the robot runs and contains points depicting objects detected. However, it was deemed that this method was less efficient at keeping track of the robot’s position relative to the map coordinate frame, than using a priority map. A priority map first generates a blank map roughly the size of the course, and then adds the accumulated obstacle data from the laser scanner, as well as detected lines generated from the line-detection node. Since the priority map has known, fixed dimensions, it is easier to keep track of the robot’s position using this type of mapping than if using a map with no fixed dimensions because the robot would have a relative origin for each trial.

5.5 Goal selection and path generation

REVO uses ROS navigation stack for path planning. The navigation stack (NavStack) takes in information from localization, orientation, obstacle and line detection, and a goal pose to output safe velocity commands sent to a mobile base.

REVO’s goal is to navigate to a GPS way-point defined in software before each run. The GPS coordinates are sent to the NavStack in a message containing an (x,y,z) formatted location which is computed by the “gps_goal” node.

NavStack’s main package “move_base” is a library native to ROS. The move_base node links together a global and local planner to accomplish its global navigation task. It also maintains two costmaps: one for the global planner, and one for a local planner. All sensory information is sent to both costmap nodes within the move_base package. The global costmap

represents all information REVO received about its environment. It continuously builds the costmap using the incoming sensor information which is carried out until the system is restarted. The local costmap contains the pool of information which is acquired from the immediate vicinity, usually a 4 meter radius around REVO. The local costmap is constantly updated, but is never stored for future use. The global costmap is used for long-term decisions, while the local costmap is used for short-term decisions.

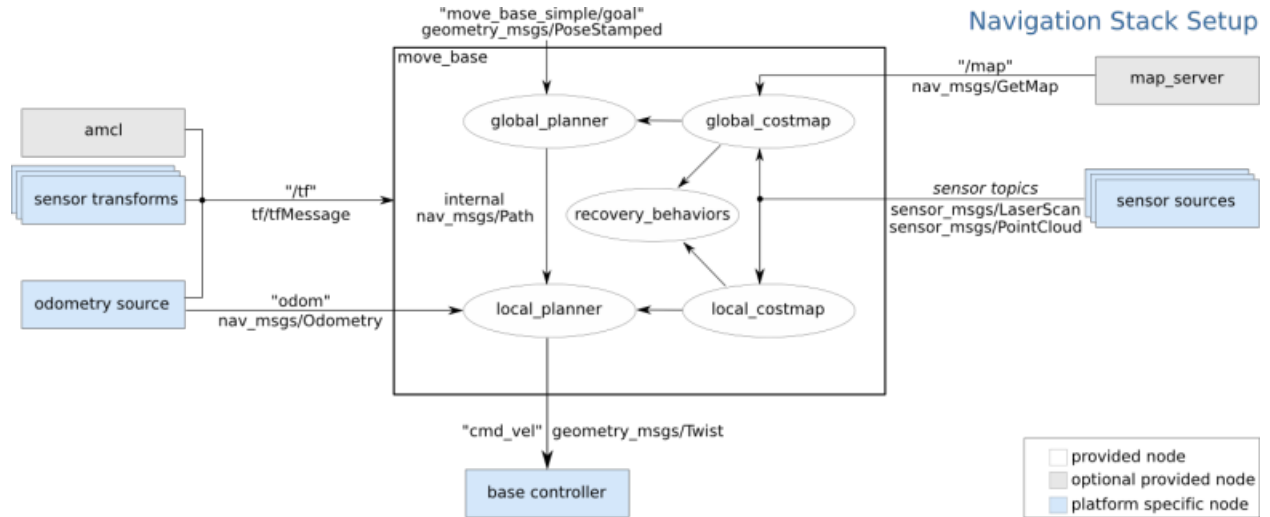

Figure 7: Navigation Stack Setup

As REVO collects sensory information, it gets increasingly difficult to extract useful information from disorganized data. Data is systematically converted to REVO's point of reference using a transform tree as shown in Figure 9. Data is systematically converted to REVO's point of reference as its using a transform tree as shown. This allows data coming from a sensor, such as the LRF, to be adjusted by translation and rotation so that all sensory data have the same origin.

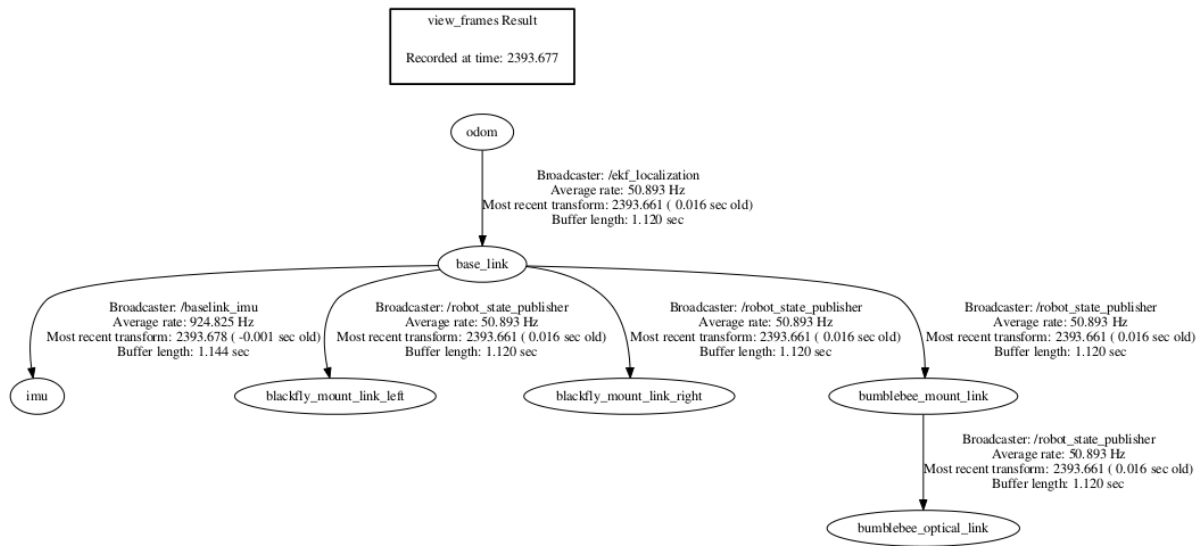

Figure 8: TF tree

6 Failure Modes, Failure Points, and Resolutions

6.1 Failure Modes

A possible software failure could occur when REVO is stuck or comes into a corner. When this occurs, the information from the local and global costmap nodes is sent to a recovery behavior node which decides between four different recovery options as shown in Figure 10. If a suitable recovery behavior cannot be achieved, the system will abort the navigation to avoid any further unwanted movement.

move_base Default Recovery Behaviors

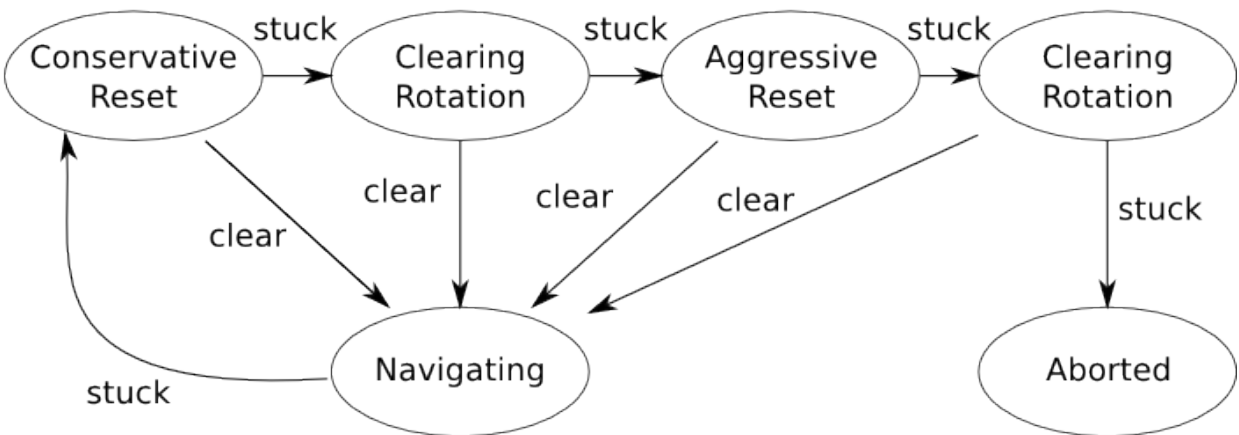

Figure 9: Recovery Behaviors

6.2 Points of failure

One foreseen mechanical failure point was small movements of the shafts which is the result of the skid-steering choice. As the robot turns, there is an axial load on each shaft. During turning, the flange shaft collar attached to the wheel had a higher clamping force than the shaft coupler that connects the motor to the shaft. This loosened the set screws on the motor collar and the axial load on the shaft caused it to move outwards, and eventually decoupling it from the motor. This problem was overcome by using a two-piece shaft coupler with eight screws that supplied ample clamping force. These couplers were designed for shaft coupling where high loads are expected.

6.3 All failure prevention strategy

An initial failure prevention strategy was designing REVO with all three engineering backgrounds. This allowed for easy software and electrical hardware integration into the mechanical structure.

6.4 Testing

The mechanical testing consisted of test driving the robot outdoors. The most prominent mechanical problem was the movement of the shafts due to inadequate clamping force from the shaft couplers, which was later resolved. Software was tested in a simulated environment, using a simulation created based on the IGVC map. Odometry, mapping and sensory were fine-tuned using this simulation, along with these, the parameters for the navigation stack were fine-tuned for the robot.

6.5 Vehicle safety design concepts

During the manufacturing period and assembly, one of EDT's main concerns were the safety of the robot with regards to the assembler. For example, the lower assembly has many sharp edges and some difficult parts to reach. When this was the case, either the corners were dulled or there was a small redesign. This can be seen with the bolts in the lower assembly that protrude only enough to fit the lock nut. Initially, while assembling the lower assembly, some of the bolts were extruding far past their necessary reach and became cumbersome to the user. This problem was overcome by either cutting the bolts once it was fully fastened or buying the appropriately-sized bolts. Another example can be seen with the corners of the upper assembly. The three point connectors were used instead of a traditional L-brackets with the exposed corners.

7 Simulations employed

7.1 Simulations in virtual environment

A replica of the IGVC map was created to test out simulations in a virtual environment. This was accomplished using Gazebo as a simulation platform (Fig. 11), to represent ground

surface texture, height maps, and various IGVC environment features. Along with this, Rviz was used to visualize the data from Gazebo (Fig. 12), allowing for easy interpretation for modification and different implementations of nodes. As the simulation platform was created to design and test theoretical concepts of the robot, these concepts needed to be transferred to a real-world situation, interfacing with physical hardware and sensors, as opposed to simulated plugins. The simulation was designed to allow for 100% transparency between simulated and real-world testing.

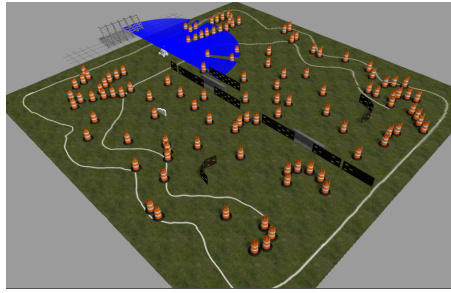

Figure 10: Gazebo Simulation

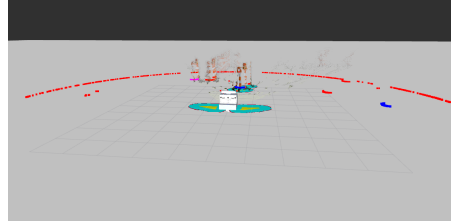

Figure 11: Rviz Visualization

7.2 Theoretical concepts in simulation

To further verify algorithm reliability, decrease the total amount of time required to setup a test to validate result, and increase safety features, theoretical concepts such as lane detection and path planning/navigation were tested, tuned and validated. These concepts were tested individually and eventually coupled together to ensure compatibility and preferred results.

Lane detection was tested and verified by comparing to IGVC standard lane width. This was converted from a two dimensional image to a three-dimensional point cloud-based on a pre-generated down projection calibration. Once the generated lanes were verified to show identical dimensions between the simulation and the realistic environment, the lane detection was ready to be tested with path-planning.

To verify the reliability and precision of path-planning, all sensed environmental hazards/obstacles (construction barrels, saw horses and lanes) were used to fine tune the heuristic planning to plot and execute the most optimal path between all obstacles, through a continuous set of waypoints.

8 Performance Testing to Data

8.1 Component testing, system and subsystem testing, etc.

The mechanical system was tested throughout the winter and spring of 2016. This test was done using a remote controller and was strictly used to test the mechanical reliability of the lower assembly. This test was repeated after failure modes were determined and fixed. As mentioned, this spawned the shaft movement. After the shaft movement was fixed, there was an opportunity to show off REVO at the UIC Engineering Expo. This was an opportunity for others to drive REVO with a remote control but this time the correct motor controller

and batteries were in place, completing the lower assembly. REVO survived the test of others handling and vigorously driving REVO for close to 45 minutes. Since REVO passed the test of nontechnical people, one can assume the mechanical design is reliable.

9 Initial Performance Assessments

Speed:

The goal speed of REVO was 3 mph. With a 13 in wheel diameter and a geared DC motor with 88 rpm, the theoretical speed of REVO is 3.4 mph. With the space, voltage requirements, and power consumption considerations, 3.4 mph is an excellent speed for REVO.

Ramp climbing ability:

Based on the expected weight of 250 pounds, the calculation used to find the power requirements was the torque of the motor multiplied by the wheel diameter. In turn, this is the same calculation if REVO were to drive up a vertical wall.

Reaction times:

REVO's path planning control loop runs at a frequency of 10Hz. This enables REVO to react to obstacles within a duration of 100 milliseconds.

Battery life:

REVO is powered by two 12V sealed rechargeable lead-acid batteries. Each battery has a capacity of 35Ah and has a max discharge current of 105A and a peak output current of 350A. This allows for approximately 90 minutes of normal run time. REVO's batteries are wired in series supplying 24V to both the Roboteq and the Backplane.

Distance at which obstacles are detected:

REVO's LRF is capable of mapping obstacles at distances of up to 10 meters.

How the vehicle deals with complex obstacles:

REVO recognizes dead ends from the costmap and looks for alternative paths, thereby avoiding any confrontations with them. If it finds itself within a dead end, the costmap marks all the obstacles, and then forces the path planner to create a path that tells REVO to exit the dead end. The costmap also forces REVO to go forward by marking the obstacles and the lane, thus enabling it to deal with switchbacks.

How the team identifies and addresses vehicle failure points and modes:

EDT has found success in addressing failures by first determining what the failure was and then, how it was derived. There were some issues that were encountered that the designer

could not solve. In this case, the design was brought to others, possibly more senior members, for advice. An example of this was a problem with the key way on the motor. The motors had a 6mm key and the shaft couplers had a .25 inch keyway, which is a touch smaller than the .25 inch so the shaft coupler did not fit. The designer thought the solution was to put the motor in the vice of the knee mill and chip away some material. The solution that was advised by a senior member was to take out the key from the motor shaft and just modify the key. This option was not known by the designer. Everyone learned from this and the platform was improved.

Accuracy of arrival at navigation waypoints:

The planner has an accuracy of 8 cm, REVO will not switch to a new waypoint until it is under 8 cm away from the current waypoint.

10 Conclusions

To conclude, this year's revision of REVO has seen great improvements from last year's on all fronts. Ease of operation was increased due to modifications to the electrical housing module, and payload module. Further testing of the electrical system made it easier to integrate new features to the system monitor and increase overall reliability. As well, the continued development of EDT's software makes the current platform one of the most robust in recent years.

Table 1: Bill of Materials

Vendor	Description	Supplier Part #	Quantity	Unit Price \$	Line Price \$
Mcmaster	6160 aluminum, 3/8" thickness, 3" wide	8975K91	1	10.07	10.07
Midwest Motion	Encoders	EM-2048	2	153.00	306.00
Midwest Motion	Motors	MMP D33-455D-24V GP81-046	2	529.00	1058.00
Mcmaster	Steel Ball Bearing Flanged Open for 3/4" Shaft Diameter,	6383K251	1	10.70	10.70
Mcmaster	low carbon steel square tube, 6 ft sections	6527K264	6	21.72	130.32
Mcmaster	Flanged Shaft Collar with Mounting Holes for 3/4" Diameter, Black-Oxide Steel	9684T3	4	56.92	227.68
Mcmaster	6160 aluminum, 1/2" thickness, 5" wide	8975K217	1	22.48	22.48
Mcmaster	Steel Ball Bearing Flanged Open for 3/4" Shaft Diameter, 1-3/4" OD, 5/8" Wide	6383K251	8	10.70	85.60
Superdroidrobots	All Terrain Robot Wheels. 13.5 outer Diameter	TD-164-013	4	26.90	107.60
Mcmaster	Quick-Disconnect Bushing	6086K19	1	14.70	14.70
Mcmaster	low carbon steel square tube, 6 ft sections	6527K264	2	21.72	43.44
Mcmaster	6160 aluminum, 1/4" thickness, 1" wide, 2' long	9872T57	1	15.03	15.03
Mcmaster	Curved-Tooth Timing Belt Pulley for 8mm Pitch, 28 Teeth	6497K711	4	47.23	188.92
Mcmaster	Quick-Disconnect Bushing	6086K19	4	14.70	58.80
Mcmaster	6160 aluminum, 3/8" thickness, 3" wide. 3 feet needed.	8975K91	1	26.10	26.10
Mcmaster	6160 aluminum, 1/2" thickness, 5" wide. 1 feet needed.	8975K217	1	22.48	22.48
Motion Industries	Gates Powergrip GT3 belts	1104-8MGT-20	2	46.99	93.98
Mcmaster	shaft collars for .75 inch shaft	6435K16	8	2.51	20.08
Mcmaster	Alloy Steel Torx DriveFlat-HeadSocket Cap Screw	94414A540	1	11.40	11.40
mcmaster	shaft collars	60845K14	2	71.44	142.88
mcmaster	stand offs, 2 in	91115A416	6	8.85	53.10
McMaster	Fully Keyed 1045 Steel Drive Shaft	1497K62	1	42.88	42.88
Mcmaster	spring standard steel key stock.	98535A450	1	9.69	9.69
Mcmaster	Aluminum Unthreaded Spacer	92510A764	16	1.40	22.40
Mcmaster	t-slot panel bracket	47065T195	16	4.95	79.20
Mcmaster	Slider, 2 pack	11435A25	1	17.79	17.79
Mcmaster	1" Aluminium T-slotted Framing, 6 feet required	47065T101	2	19.79	39.58
Mcmaster	3 Way external corner block	47065T244	6	9.89	59.34
mcmaster	aluminum 4-40 screws, 3/8" length	98511A230	1	10.68	10.68
mcmaster	self closing lightweight hinge	1481A22	1	24.25	24.25
Mcmaster	Flanged Button-Head Socket Cap Screw,	97654A265	1	6.84	6.84
Mcmaster	Work-Load Rated Gasket-Sealing Draw Latches	4567A1	4	12.86	51.44
Mcmaster	Polycarbonate Sheet 24x24	8574K57	1	102.46	102.46
Mcmaster	LightweightSelf-ClosingSpring Hinge	1481A13	1	11.38	11.38
Mcmaster	Impact-ResistantPolycarbonate Sheet 1/4" Thick,6" x 12",Clear	8574K282	1	8.52	8.52
Mcmaster	Female Threaded Hex Standoff	91115A422	4	11.80	47.20
Mcmaster	General Purpose Low-Carbon Steel, Sheet, 0.060" Thick, 24" x 48"	6544K21	1	43.92	43.92
Mcmaster	100 aluminum sheet, .125" thick, 48" x 96"	88685K29	1	316.08	316.08
All Control	sick tim mounting brackets	2068398	1	179.51	179.51
Mcmaster	aluminum t slot framing, 2 in extrusion	47065T107	1	12.85	12.85
Mouser Electronics	Real Time Clock IC	700-DS3231S#	3	8.22	24.66
Mouser Electronics	RF Development Tools 915 MHz Transceiver	712-EVM-915-DTS-FCS	2	43.28	86.56
Tiger Direct	Intel NUC Core i7 5557U Kit M.2/SATA3	GNT-102920959	1	476.99	476.99
Tiger Direct	Kingston HyperX Impact 16GB Notebook Memory	KIO-102509388	1	99.99	99.99
NewEgg	The Samsung SM951 M.2 PCIe SSD (AHCI model)	N82E16820147425	1	219.99	219.99
Digikey	CONN HEADER 10POS 2MM RT ANG TIN	H10247-ND	15	0.75	11.25
Mouser	Transceiver	712-EVM-915-DTS-FCS	2	43.28	86.56
ZED	Zed Stereo Camera		1	449.00	449.00
nvidia	NVIDIA Jetson TK1		1	192.00	192.00
microstrain	3DM-GX3-35	3DM-GX3-35	1	2595.00	2595.00
hemispheregnss	GPS: Hemisphere V103 Smart Antenna	GPS: Hemisphere V103 Smart Antenna	1	3200.00	3200.00

Statement of Integrity: The engineering and design work documented in this report and implemented into this vehicle by the current student team is significant and equivalent to credit that would be awarded in a senior design course.

Dr. Miloš Žefran
Professor, Director of Graduate Studies
UIC College of Engineering
Department of Electrical and Computer Engineering
mzefran@uic.edu

Signature: Miloš Žefran